



Aluminium sliding patio doors



**EZISLIDE**

# CONTENTS

|                     |    |
|---------------------|----|
| About the Products  | 03 |
| Key Features        | 04 |
| Profiles            | 06 |
| Colours & Finishes  | 08 |
| Custom made for you | 10 |
| Safe & Secure       | 12 |
| Handles             | 14 |
| Machinery           | 15 |



A system for sliding window and doors with straight aesthetic

Which boasts a central minimalistic visible section.

47mm  
interlock

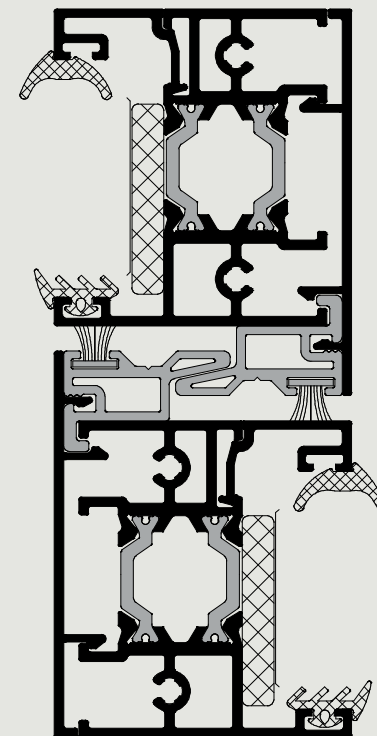

# KEY FEATURES

*The Ezislide system aims to be the best in the industry, striving to meet the needs of the ever changing retail and trade customers. There are many reasons to choose an Ezislide aluminium patio doors; here are their key features:*

#### MINIMALIST SASH ENCOUNTER

Central minimalist sash encounter of only 47mm of visible section

#### STAINLESS STEEL RAILS

Stainless steel rails that allow for ultra smooth sliding

#### UP TO 34 MM GLAZING

This system allows maximising the glazing capacity up to 34mm increasing the acoustic and thermal performance.





# THE PROFILE

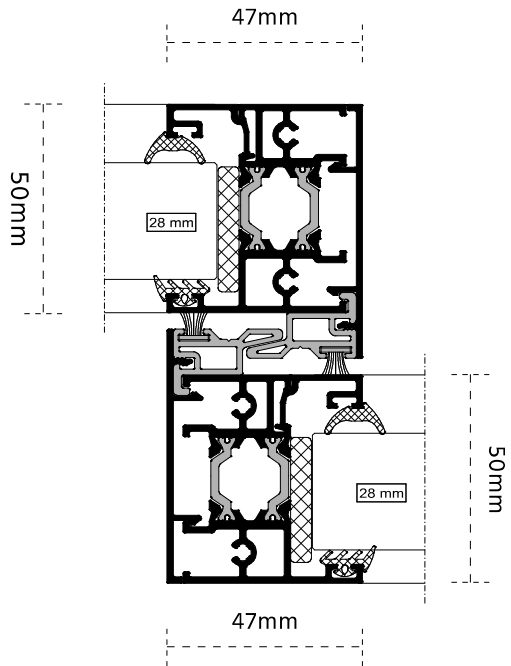
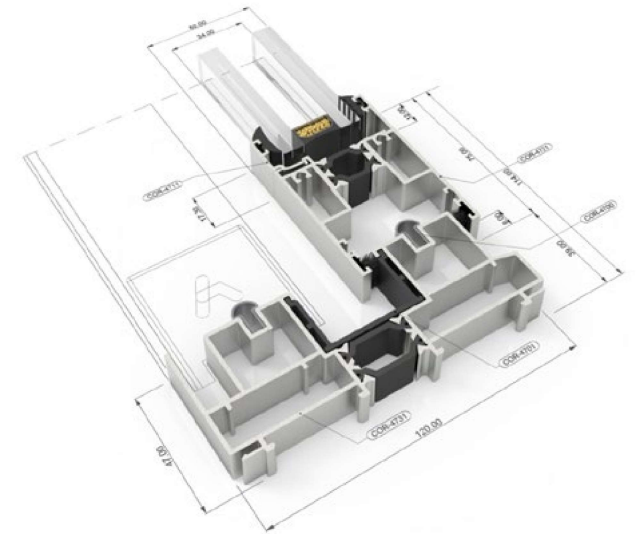

Slimline interlock

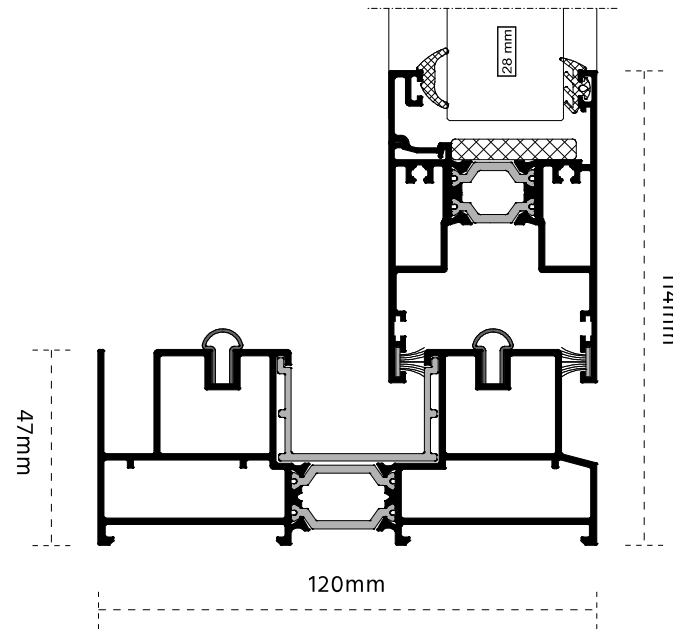

Double track

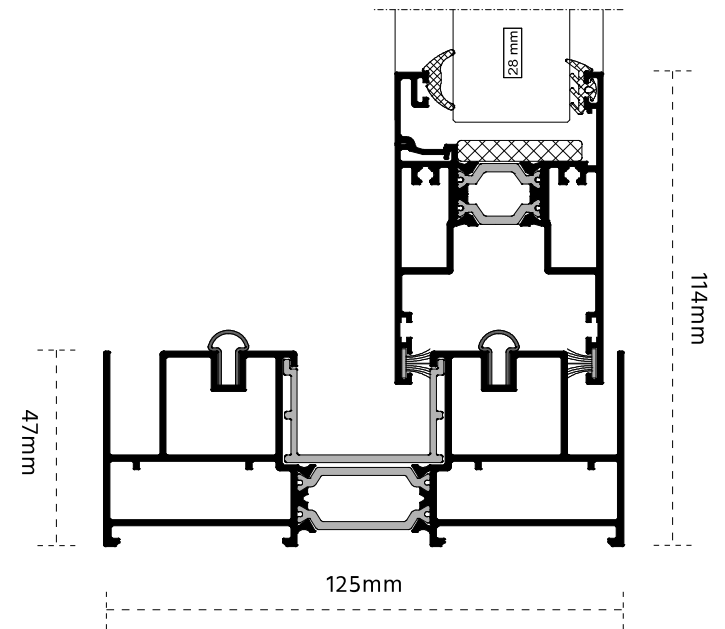

Double track (flush option)

## DESCRIPTION

Ezislide system for sliding doors

Interlock profile 47mm

Stainless steel rails that allow for ultra smooth sliding

## TECHNICAL DATA

### Opening possibilities

Sliding of 2, 3, 4 & 6 sashes

### Sections

Frame 120mm & 115mm

Three-rail 185mm

Sash 50mm

## Maximum dimensions per sash

Width (L) = 2,500mm

Height (H) = 3,000mm

## Maximum weight per sash

280Kg

Please consult regarding maximum weight and dimensions for other opening types

## Colour powder coating

RAL, mottled and rough

## ENERGY EFFICIENCY

Thermal Transmission Coefficient

Uw from 1,1 (W/m<sup>2</sup>K)

## Acoustic insulation

Maximum acoustic insulation Rw = 40 dB

Maximum glazing thickness: 34mm

## CATEGORIES ACHIEVED AT TEST CENTRE

Air permeability (EN 12207): CLASS 3

Water tightness (EN 12208): CLASS 7A

Wind resistance (EN 12210): CLASS C5

Security Test: **PAS24**  Passed

Reference test: 1,800mm x 2,200mm 2 sashes

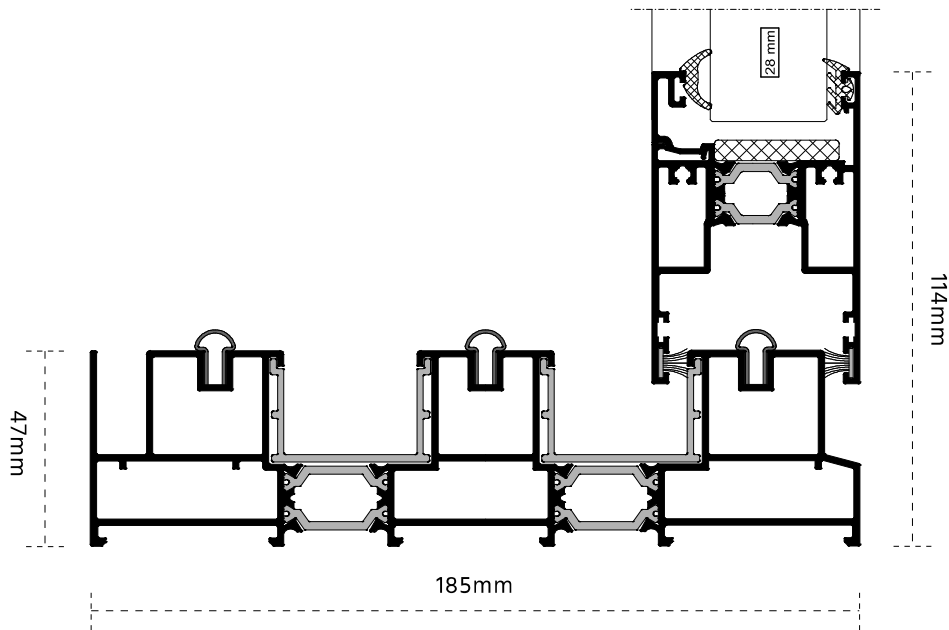

Triple track

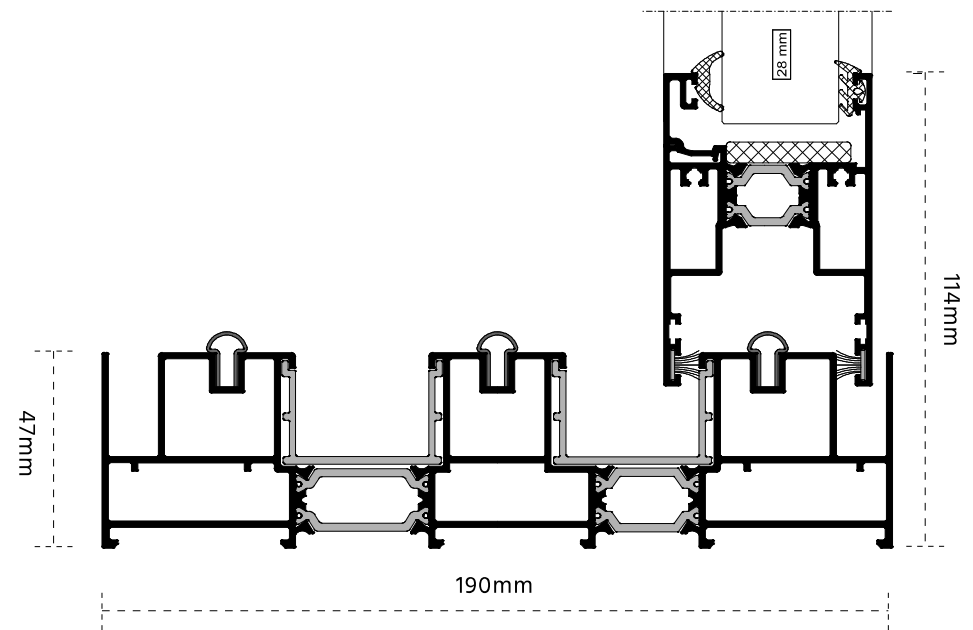

Triple track (flush option)

# COLOURS & FINISHES

*We have over 150 different RAL colours to choose from,  
So you can be sure you'll find a colour that suits you.*

As you would expect from the current generation of sliding patio doors, the Ezislide sliding patio doors offer the full range of powder coated finishes as well as dual colour and specialist powder coat availability.

Our sliding doors are powder coated in the standard colours of the Classic RAL System. RAL, the European colour standard system, is used in industry, architecture and construction applications. It defines the industry standard for aluminium coatings and is the most popular European colour standard in today's market.

Our sliding doors are available in a multitude of all RAL colours and also dual colours so you can have one colour for outside and a different colour for inside. The most popular bi-fold door RAL colours are grey, black and white – RAL 7016 Anthracite grey, RAL 9005 Black and RAL 9016 White – although there are around 200 colours listed on the RAL chart that cover the whole spectrum.

Gloss or matt finishes can be applied, depending on personal requirements and we keep grey, black and white in stock to ensure a fast turnaround when an order has been placed.

If you require further information on sliding door RAL colours or on any other aspect of sliding door installation, please do not hesitate to contact us, we are always happy to help.





*Popular colours are*

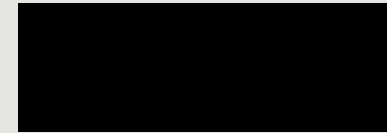

Black – RAL 9005



Anthracite Grey – RAL 7016



Mid Grey – RAL 7042

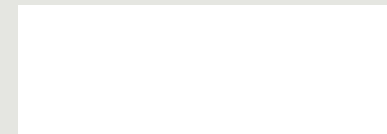

White – RAL 9016

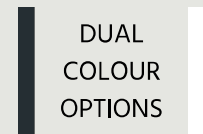

DUAL  
COLOUR  
OPTIONS

Other colours come  
in a matt finish

# ROOM WITH A VIEW

*All of our sliding doors are bespoke and custom made to your requirements*

Fixed and sliding opening options

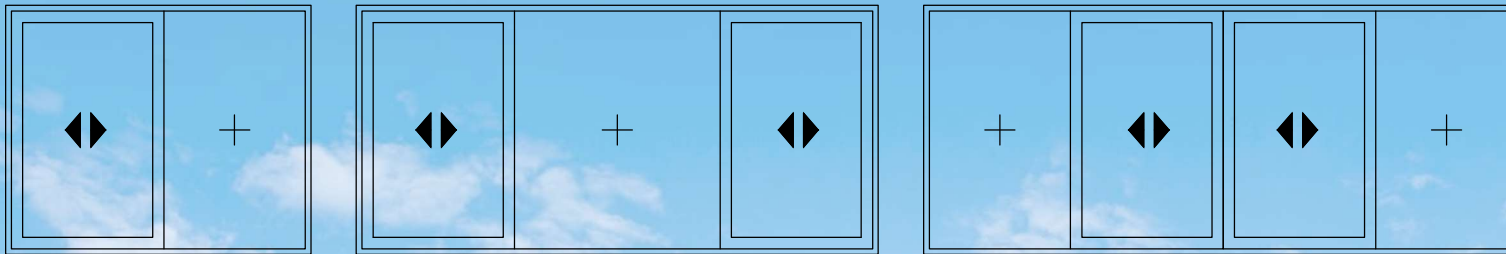

Sliding / opening options – 2 and 3 track

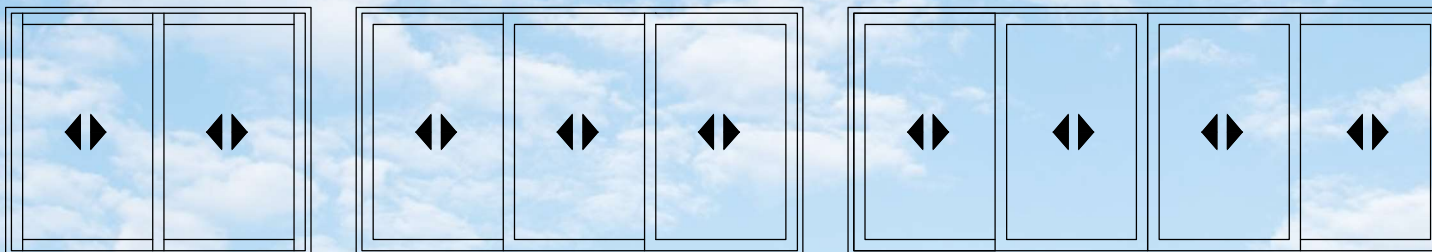

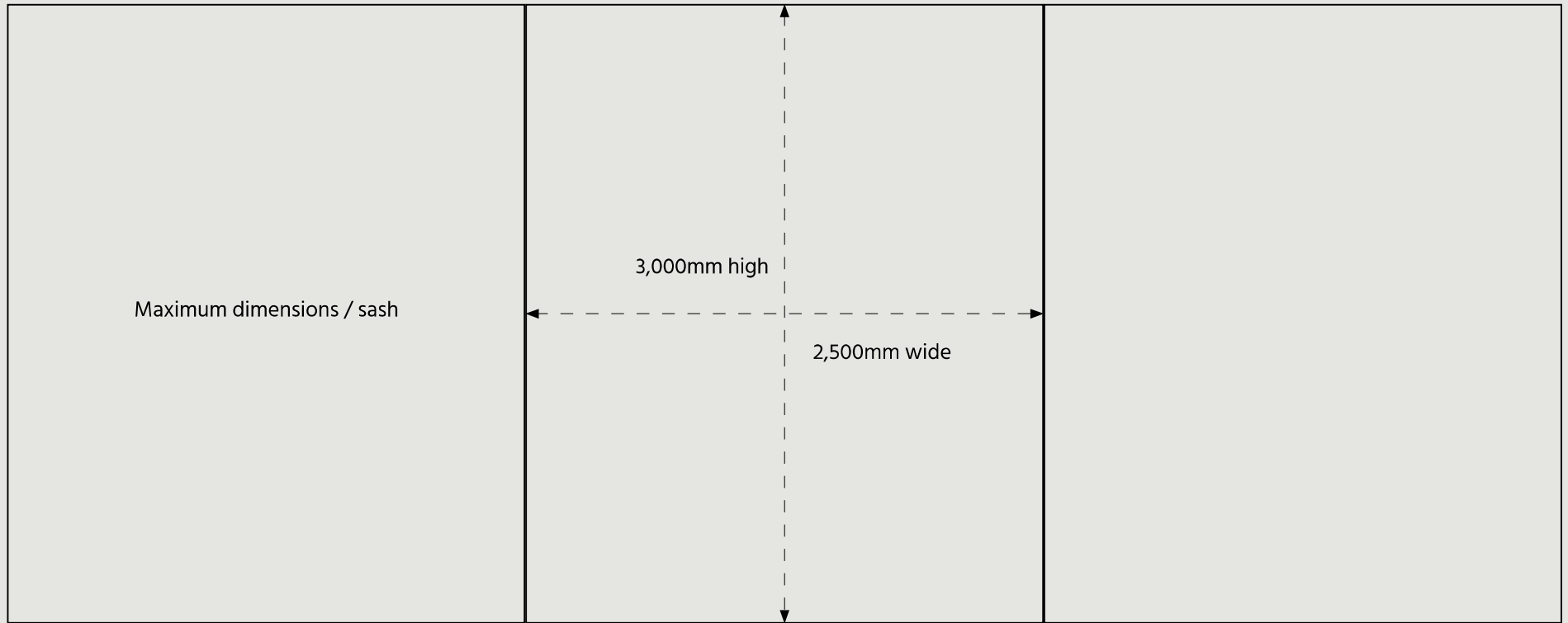

Sliding / opening options – 3 track

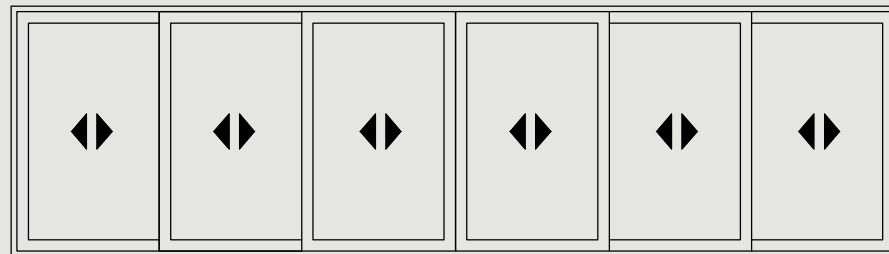
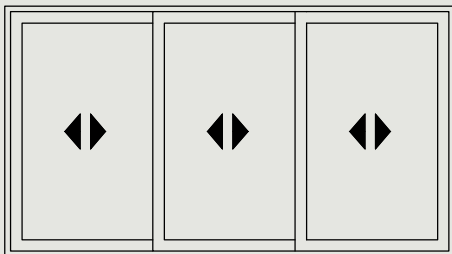

# SAFE & SECURE

*Because of the importance of security, it is always a major design priority for our sliding patio doors.*

- Maximum security: locking with inside and outside keys.
- Integration of the locking system within the profiles, with a minimalist aesthetic.
- It allows for until 4 locking points (mushroom security cams).
- Regulation system for the lock's tightness.





Secured by Design



Official Police Security Initiative

SLIDING PATIO DOORS

# EZISLIDE HANDLES

The handles are used constantly, without a second thought, so the handles on a sliding door have to be strong and reliable and ready to withstand the years of use that they will receive.

Our sliding door handles are made with our customary care and dedication; our handles are modern, with elegant styling whilst mixing a balance between their strength, sleek design and flawless functionality.

- Minimalist and straight aesthetic.
- Total adaptability to the transmission box and with the multi-lock system.
- Available in door version.



*These handles are available in black, anthracite grey or white.*

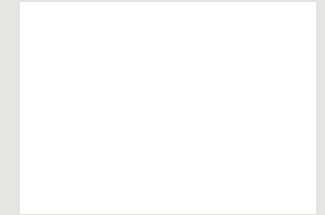

*Optional D-handle is also available and can be supplied in black, anthracite grey, white or silver (shown right).*

*Internal door handle*



*External door handle*



# MACHINERY

*Joining our line up of specialist equipment is our new AL220 cutting and machining centre, capable of handling all sawing, milling, drilling and marking operations on a single platform. Thanks to an intelligent computer control system and powerful servo motors, it can work quickly and precisely, and is easily operated with a 15-inch touch screen.*

In the years to come it will enable us to make more outstanding aluminium patio and bi-fold doors, even more quickly and efficiently.

By purchasing a whole array of state-of-the-art manufacturing equipment, we've quickly been able to become a ground-breaking business in British fenestration.



*When you order your sliding patio doors you won't be waiting for ages for your delivery thanks to our continued investment in state-of-the-art machinery to help maintain our signature speedy lead times.*





**EZISLIDE**

